

Replacement Parts List

NOTE: If requested color is not available, similar color will be substituted.

Part	Cost	Quantity	Total Cost
Crotch Strap/Buckle	\$4.99	X _____	= \$ _____
Harness Strap	\$2.00	X _____	= \$ _____
Pad Set	\$42.00	X _____	= \$ _____
Chest Clip	\$1.50	X _____	= \$ _____
Locking Clip	\$2.50	X _____	= \$ _____
Tether Kit	\$9.99	X _____	= \$ _____
Latch Kit	\$24.99	X _____	= \$ _____
Instructions	\$0.00	X _____	= \$ _____

Merchandise Total \$ _____

Shipping and handling: \$ _____

Up to \$25.00\$5.95	\$100.01 to \$150.00\$10.95
\$25.01 to \$50.00\$6.95	\$150.01 to \$200.00\$11.95
\$50.01 to \$75.00\$8.95	\$200.01 and up\$13.95
\$75.01 to \$100.00\$9.95	Outside Continental USA	\$10.00

Sales Tax \$ _____
 (Indiana, California, Arkansas, and Massachusetts residents add applicable sales tax.)

Grand Total \$ _____

No shipping and handling on instructions for quantities under 6. Add \$.50 for each instruction over 6, then add applicable shipping and handling.

Fill Out For Credit Card

Visa Mastercard

Card Exp. Date: _____

Cardholder's Name: _____

Card Number: _____

Signature _____

CUT ON DOTTED LINE

Eng. 4358-5356A

Alpha Omega, All in One Instruction Manual

www.djgusa.com

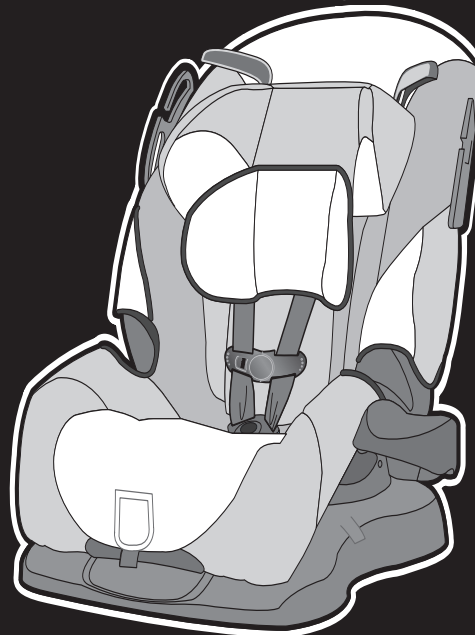

This child restraint is designed for use by children whose:

Weight:
5-80 pounds
(2.3-36.3 kg)

Height:
19-52 inches
(48-132.1 cm)



Read all instructions **BEFORE USING** this child restraint.

KEEP INSTRUCTIONS FOR FUTURE USE.

⚠ IMPORTANT!

Failure to follow the warnings on the labels and in the instruction manual can result in the death or serious injury of your child.

Para recibir las instrucciones en español, llame al 1-800-544-1108 o solicítarse por escrito al dirección por arriba.

Before You Begin...

Thank you for choosing this car seat, referred to throughout this manual as a child restraint. The DJG family is committed to creating a child restraint with the most comfort and convenience available today.

Remember, parents are a child's first teachers and examples. If you always buckle your seat belt, your child will think it is the natural thing to do. Make it a firm rule that the vehicle does not go until everyone is buckled up. Make no exceptions.

No one can predict if use of a child restraint will prevent injury or death in a particular crash. However, combined with careful driving, proper use of a child restraint can lower a child's risk of injury or death in most crashes.

Your child's safety is worth the time it will take to read and follow these instructions. After reading, if you still have questions or have any problems with this child restraint, please contact our Consumer Relations Department at:

Dorel Juvenile Group, Inc.

Website: www.djgusa.com
 Fax: 1-800-207-8182
 Mailing Address: Dorel Juvenile Group, Inc.
 P.O. Box 2609
 Columbus, IN 47202-2609
 Telephone: 1-800-544-1108
 7 A.M. to 6 P.M. EST M-TH
 7 A.M. to 4:30 P.M. EST FRI

On the back of the shell there is an expiration date for use of this child restraint. Do not use this seat after the expiration date.

Table of Contents

Warnings.....	2-4
General and Warm Weather Use.....	5
Registration and Recall	5
Aircraft Installation	5
Understanding Your Vehicle	6-7
Child Restraint Parts	8-9
Choosing Restraint and Position	10
Preparing Child Restraint to Fit Your Child	11
Check Harness/Headrest Height.....	12
Accessories (on select models)	13
Securing Your Child in Child Restraint.....	14-15
Removing Child from Child Restraint	16
Reclining the Child Restraint	17
Choosing LATCH or Vehicle Belts.....	18
Knowing Your Vehicle Belts	19-20
Locking Clip	21-22
Rear-Facing Use	23
Rear-Facing Installation.....	24
Vehicle Belt	25-26
LATCH.....	27-30
Forward-Facing Use	31
Forward-Facing Installation	32
Vehicle Belt	33-34
LATCH.....	35-37
Adjusting the Tether Strap.....	38-39
Belt-Positioning Booster Use	40
Removal of Harness	41-42
Belt-Positioning Booster Installation.....	43-44
Reinstall Harness	45-48
Removing Seat Pad for Cleaning	49-51
Troubleshooting	52
Warranty	53
Replacement Parts Order Form	57-58

WARNING

Failure to follow these warnings can result in the serious injury or death of your child. To help you recognize those instructions which are most critical for your child's safety, we use this symbol :

 According to accident statistics, children are safer when properly restrained in the rear seating positions than in the front seating positions.



 Never place a child rear-facing in a seating position with an active frontal airbag.

 This child restraint must always face the rear of the vehicle and be in the fully reclined position when the child weighs between 5-35 lbs. (2.3-16 kg) and is less than one year old.

 Never place a child less than one year old forward facing.

 Check vehicle instructions for more information about air bag/child restraint use.

 Make sure the harness height is correct for your child's size.

 The harness must be snug.

 Do not lubricate buckles and fasteners.

2

WARNING

 The vehicle or LATCH belt must stay tight at the belt path. When you switch from one mode to the next, review the sections of this instruction manual that apply to that mode. If you don't, your child could be seriously injured or killed.

 Never take your child out of the child restraint or try to tend to your child's needs while the vehicle is moving. Never leave child unattended.

 Do not use a child restraint with damaged or missing parts.

 Do not use cut, frayed or damaged harnesses.

 Do not substitute parts or try to modify the child restraint in any way.

 Do not use a child restraint that has been in a crash. You must get a new child restraint.

 Use the child restraint only on vehicle seats that face forward. Do not use on seats that face the sides or rear of the vehicle.

 Check the vehicle or LATCH belt before each use. Use only if the belt can be tightened properly and securely.

 This child restraint should be securely belted in the vehicle even when not in use. In a crash or sudden stop, an unsecured child restraint could injure other occupants.

3

WARNING

- ⚠ Do not use this child restraint if the midpoint of your child's head is above the top of the child restraint's headrest.**
- ⚠ Dorel Juvenile Group does not recommend the use of any child restraint accessories except those provided by DJG.**
- ⚠ Never allow any child to play with this child restraint; it is not a toy.**
- ⚠ Secure the top anchorage strap (tether) provided with this child restraint as specified in both the vehicle and child restraint manufacturer's instructions.**
- ⚠ Do not remove any of the warning labels or other labels on the child restraint.**
- ⚠ Placing your child in a hot child restraint may result in burns.**
- ⚠ Do not use this child restraint without the seat pad.**
- ⚠ Read instructions for other warnings.**

General and Warm Weather Use

To help protect your vehicle seat's upholstery from damage, use a towel underneath and behind child restraint.

To avoid your child being seriously burned, take the following precautions:

1. Park in the shade or where sun does not directly hit the child restraint.
2. Cover the child restraint with a sheet or blanket when not in use.
3. Check for hot seat and buckles before placing child in child restraint.

Registration and Recall Information

Child restraints could be recalled for safety reasons. You must register this restraint to be reached in a recall. Send your name, address and the restraint's model number and manufacturing date to:

Dorel Juvenile Group, Inc.
 PO Box 2609, Columbus, IN 47202-2609
 Attn: Consumer Relations or
 register online at www.djgusa.com/registration/carseat/us
 or call 1-800-544-1108

For recall information, call the U.S. Government's Vehicle Safety Hotline at 1-888-327-4236 (TTY: 1-800-424-9153), or go to <http://www.NHTSA.gov>.

Aircraft Installation

This child restraint is certified for aircraft use only when used with the internal harness. Do not use as a belt-positioning seat because aircraft seats do not have shoulder belts. Use on forward-facing aircraft seats only and in a position where the lap belt can be tightened securely. This child restraint is installed in an aircraft seat the same way it is installed in a vehicle.

Use the child restraint only with F.A.A. certified equipment. Contact the airline prior to taking a child restraint on board in order to comply with their specific regulations.

Understanding Your Vehicle

Your vehicle's features may be considerably different than those pictured here. Consult your vehicle owner's manual to help identify your vehicle's specific features.

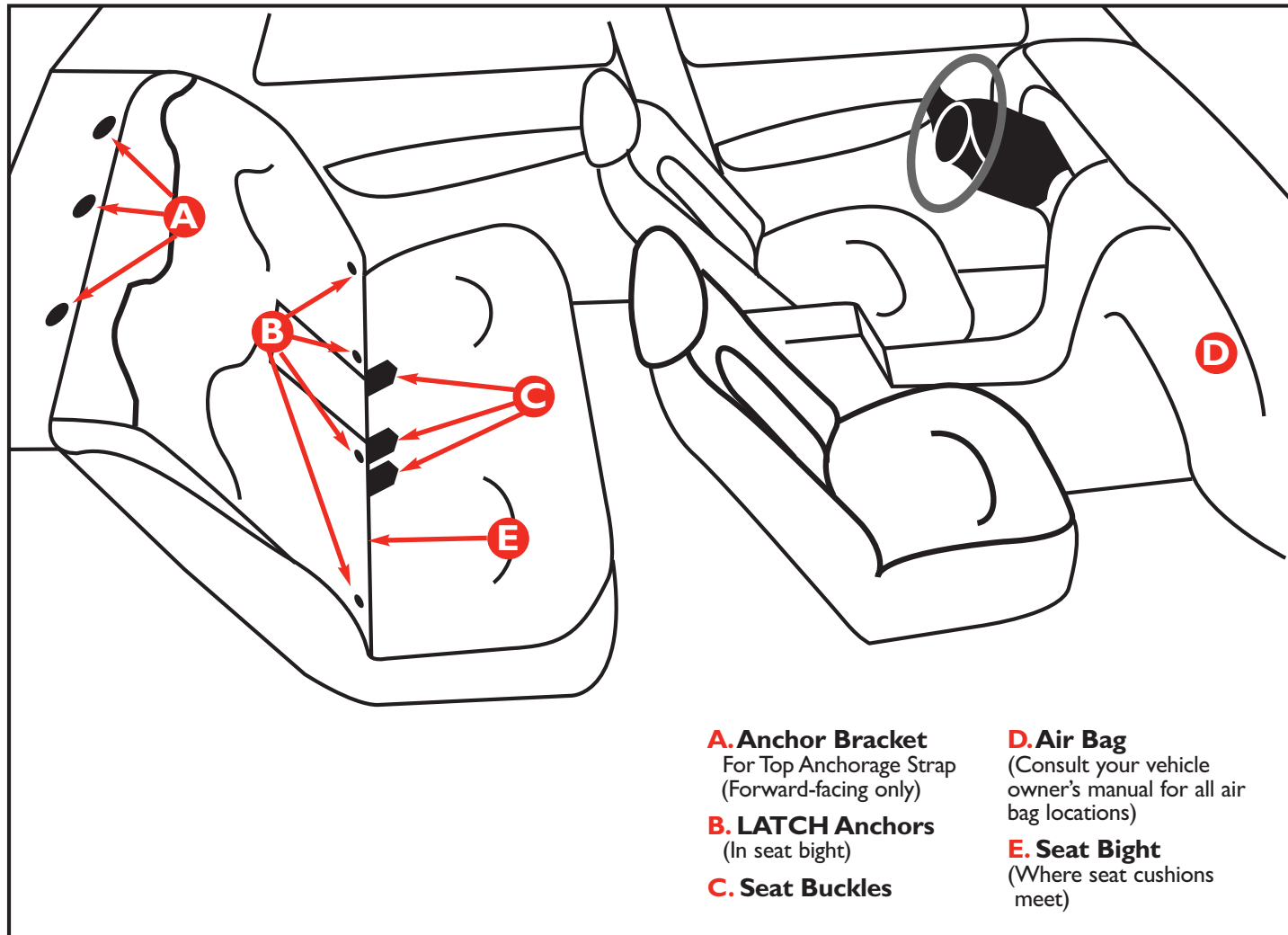

Child Restraint Parts

Front

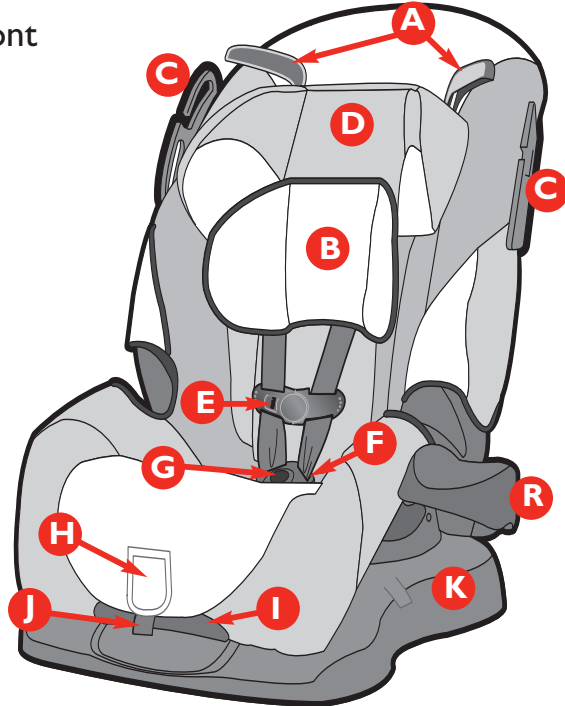

- A. Harness/Headrest Adjuster**
- B. Pillow**
(on select models)
- C. Shoulder Belt Positioning Guide**
- D. Adjustable Headrest**
- E. Chest Clip**
- F. Buckle Plate**
- G. Buckle**
- H. Harness Release Lever**
(under flap)
- I. Recline Lever**
- J. Harness Adjustment Strap**
- K. Base**

Back

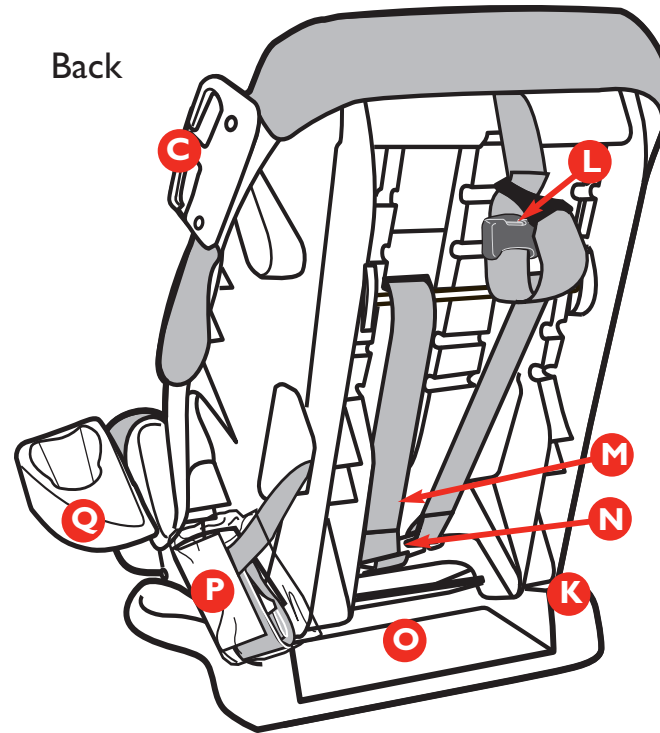

- L. Top Anchorage (Tether) Strap & Hook**
- M. Locking Clip**
(behind harness)
- N. Splitter Plate**
- O. Instructions**
- P. LATCH Belt**
(may be between pad and shell)
- Q. Cup Holder**
(on select models)

Choosing Restraint and Position

Your child's height, weight and age determine how your child restraint should be placed in the vehicle and which restraint should be used.

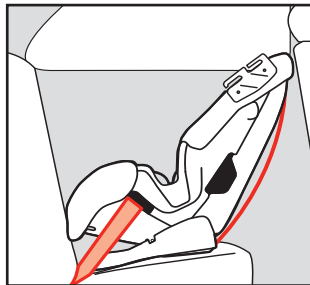

**5-35 lbs (2.3-16 kg)
19-36 in. (48-91 cm)**

Rear-Facing using 5-point harness

Child and child restraint face the back of the vehicle and are placed in the back seat.

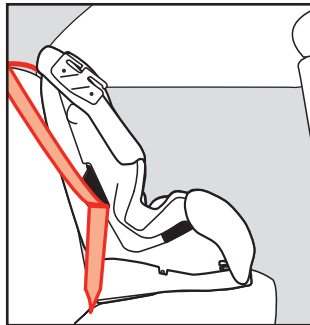

**22-50 lbs (10.1-22.6 kg)
34-45 in. (85.1-114.3 cm)
and Over 1 Year Old**

Forward-Facing using 5-point harness

Child and child restraint face the front of the vehicle and are placed in the back seat.

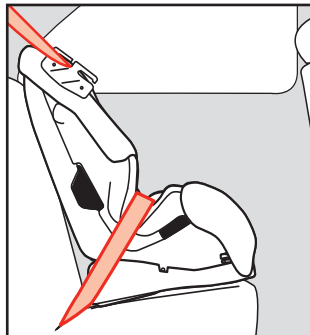

**40-80 lbs (18.1-36.3 kg)
43-52 in. (110.1-132.1 cm)
and Over 1 Year Old**

Belt-Positioning Booster using vehicle lap/shoulder belt combination

Child and child restraint face the front of the vehicle and are placed in the back seat. 5-point harness is removed.

Preparing Child Restraint to Fit Your Child

You MUST make these adjustments with your child before you install the child restraint in the vehicle.

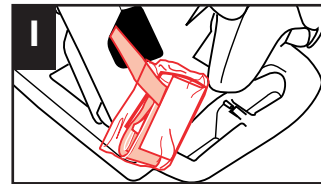

Make sure LATCH belt packaging is pulled free of child restraint shell.

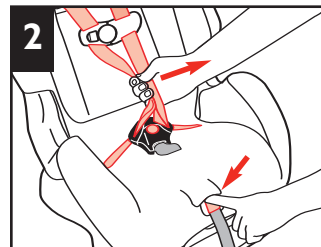

Loosen harness by pushing down on the harness release lever (under the flap in front of the restraint) while pulling out on the harness straps just above the buckle.

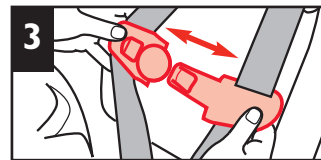

Press on chest clip release button and pull apart.

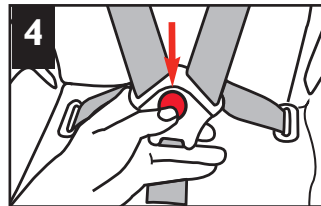

Press red button on the buckle to release the buckle plates. Place harness over sides of child restraint.

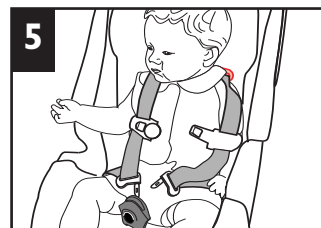

Place the child's bottom and back flat against the child restraint. This will increase comfort and allow the harness to properly tighten.

Check Harness/Headrest Height

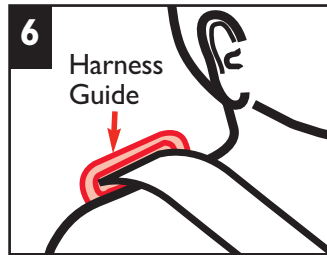

Rear-Facing Position: Harness guide must be **even with or just below** the shoulders.

If the harness guide is above the child's shoulders with the headrest in the lowest position, **do not** use this child restraint. Use an infant child restraint instead.

Forward-Facing Position: Harness guide must be **even with or just above** the shoulders.

If the harness guide is below the child's shoulders with the headrest in the 4th highest position, the child weighs at least 40 lbs. (18.1 kg) and is over 1 year old, convert the seat to a belt-positioning booster.

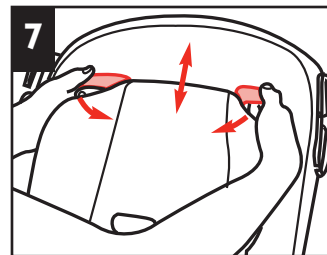

Rotate headrest/harness adjusting levers in. Move headrest up or down to adjust. Make sure headrest is locked into place.

NOTE: The highest position is for belt-positioning use only.

⚠ WARNING:

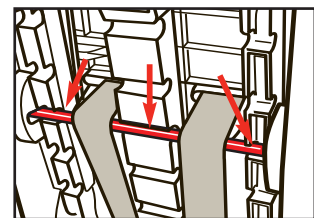

Make sure metal bar is locked into position. Failure to do this can result in serious injury or death.

Accessories (on select models)

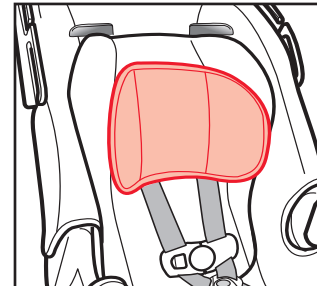

Infant Pillow (on select models): The pillow provides extra comfort for your child.

To remove the pillow, from the back of the pillow, undo both fastening strips that attach the pillow to the harness straps.

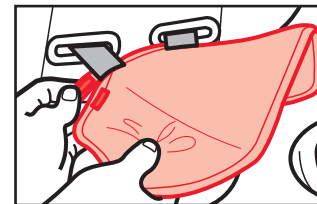

To replace the pillow, thread the fastening strips behind each harness strap. Attach the fastening strips to the pillow.

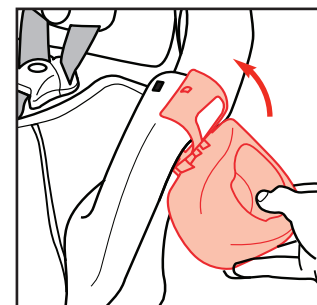

Cup Holder (on select models):

Pull pad off corner. Hook bottom of cup holder to edge of shell. Rotate cup holder up until tab on cup holder snaps into hole on shell. Replace pad.

Securing Your Child in the Child Restraint



1 Position harness straps over the child's shoulders.

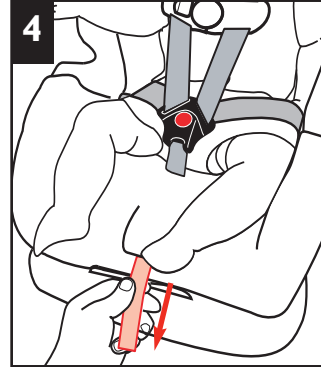

4 Pull on harness adjustment strap to tighten harness snugly.

NOTE: A snug strap should not allow any slack. It lies in a relatively straight line without sagging. It does not press on the child's flesh or push the child's body into an unnatural position.

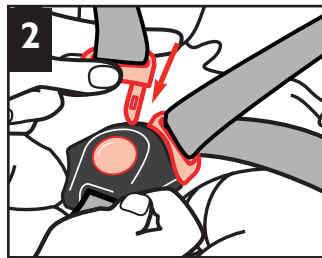

2 Push each buckle plate into buckle until you hear a "click". Remember to always pull up on harness straps to make sure buckle is locked tightly.



5 Position the chest clip at mid-chest (even with armpits), away from the child's neck.

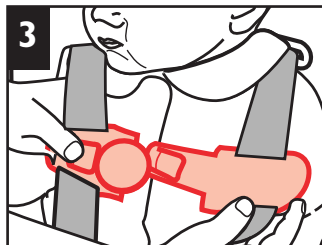

3 Snap the chest clip together.

⚠ WARNING:
Failure to fasten and tighten the harness system correctly can result in serious injury or death.

Removing Your Child from the Child Restraint



Loosen harness by pushing down on the harness release lever that is under the flap while pulling out on the harness.

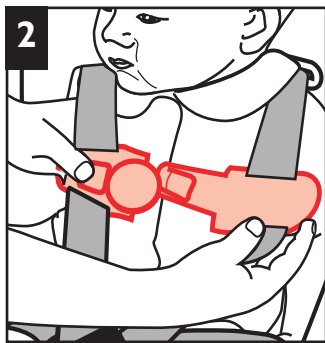

Press on release button and pull apart.

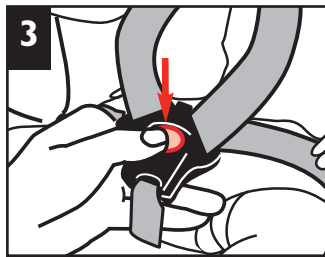

Press red button on buckle to release the buckle plates. Place harness over sides of child restraint. Remove child.

Reclining the Child Restraint

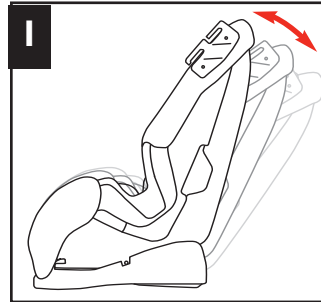

This child restraint has 3 recline positions: upright, semi-reclined (Forward-facing only) and reclined.

Rear-Facing - Must be fully reclined.

Forward-Facing - Semi-reclined or upright.

Belt-Positioning Booster - Must be fully-upright.

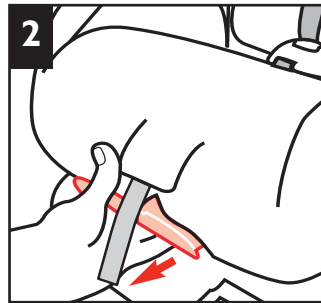

To fully recline, pull out on handle and push top of child restraint back.

For upright position, pull out on handle and pull child restraint up.

Choosing LATCH or Vehicle Belts

The LATCH System

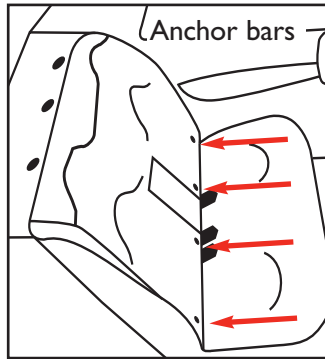

LATCH means **L**ower **A**nchors and **T**ethers for **C**hildren. Not all vehicles manufactured before September 2002 were equipped with LATCH.

The LATCH system allows a child restraint to be secured in the vehicle without using the vehicle belt system and can **ONLY** be used in vehicles that have the anchor bars installed.

Check your vehicle owner's manual to see which seating positions may be equipped with the LATCH system.

Vehicle Belts

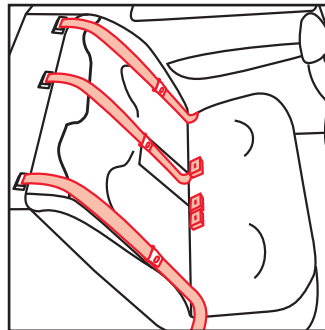

If LATCH is not an option, you will use your vehicle's belts. There are some vehicle belts that will not work with a child restraint or will require special attention. See next page for specific instructions.

Knowing Your Vehicle Belts

Not all vehicle belts will work with this child restraint. You must determine if your vehicle's belts are compatible with this child restraint. If you will use the LATCH system, refer to the LATCH section.

ELR - Emergency Locking Retractor Belts

Definition: These belts only lock in a sudden stop or crash. To see if you have this type of belt, pull on the lap belt, let it return part way, then pull on it again. If it moves freely, it is an ELR belt and the child restraint could work loose during normal driving. Refer to your vehicle owner's manual.

Some ELR belts will convert to Automatic Locking Retractor (ALR) belts if you pull the belt all the way out. Refer to your vehicle owner's manual.

ELR shoulder belts either require a locking clip or cannot be used with any child restraint. **Note: You may use an ELR lap and shoulder belt when using this seat as belt-positioning booster; no locking clip is required.**

ELR lap-only belts must be replaced with a manual belt; contact your vehicle dealer. A locking clip will not correct this problem.

Automatic/Passive vehicle seat belts

An automatic (passive) 2-point belt has no lap belt. You must install a lap belt to secure a car seat. You may also need to install an extra lap belt for an automatic 3-point belt. Refer to the vehicle owner's manual. A locking clip will not correct this problem.

Vehicle belt too short

Contact your vehicle dealer for a seat belt extender.

Belts in center of the door or side panel (A) or middle of the vehicle seat cushion (B).

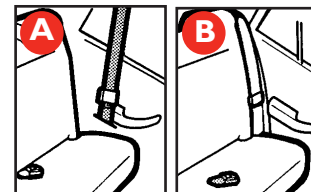

You must move the child restraint to another seating location. A locking clip will not fix this problem. See "Locking Clip" section.

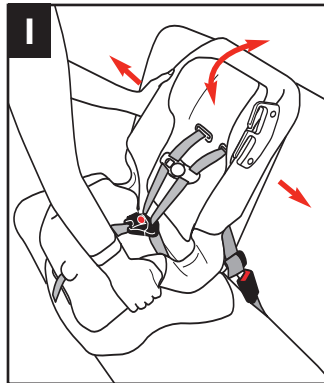

Manual Belts

Manual lap belts are common in the center rear seat and can allow the child restraint to loosen when it is tilted or jarred. After tightening the lap belt securely, tilt and push the child restraint forward and to both sides. If no loosening occurs, your child restraint should be secure.

If loosening does occur, try the following: If the buckle plate slides on the belt, turn the buckle plate over. If the buckle slides, turn the buckle. Refasten the vehicle lap belt. The release button should face **out** after twisting so that it is easy to reach in an emergency.

If the lap belt continues to loosen, the child restraint must be moved to another location in the vehicle. A locking clip will not correct this problem; see your vehicle owner's manual.

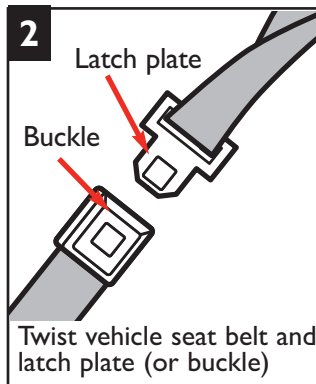

⚠WARNING

Failure to check and adjust the manual belt as described above could result in serious injury or death.

Locking Clip

NOTE: The locking clip is located on the back of the seat. You do not need a locking clip when using this seat as a belt-positioning booster.

Remove the locking clip when the seat belt is not being used with a child restraint. **A locking clip will not fix all types of seat belt problems.**

Before you put your child restraint in the vehicle, buckle the lap/shoulder belt. Pull on the lap belt portion. If it loosens or slips, you must either use a locking clip to hold the seat belt tight or move the child restraint to another seating location.

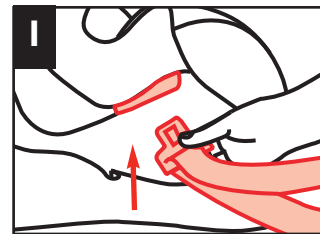

Thread both vehicle lap and shoulder belts through the slot (as shown) and out other side. Buckle. Pull up on shoulder belt until all slack is out and lap belt is tight.

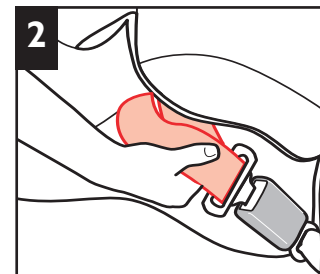

Grasp both vehicle belts together just behind the buckle plate and unbuckle. **NOTE:** If the buckle plate ends up behind the child restraint, grasp the belts to the outside of the child restraint, as close to the buckle plate as possible.

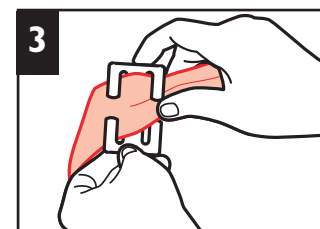

Thread both portions of the vehicle belt onto the locking clip, as close to the buckle plate as possible.

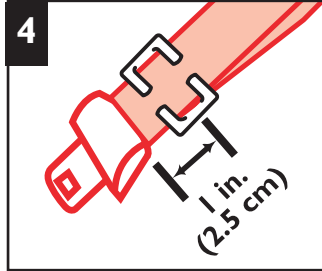

4 Position locking clip about 1 in. (2.5 cm) from vehicle belt's buckle plate.

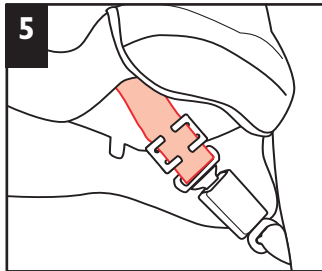

5 Rebuckle belt. Lap belt portion should now be tight. If not, remove locking clip and repeat all steps.

Rear-Facing Use

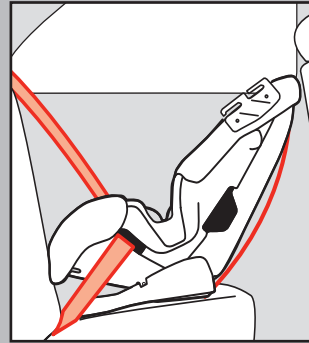

Lap/Shoulder Belt

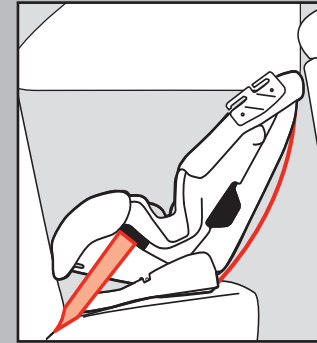

Lap Belt

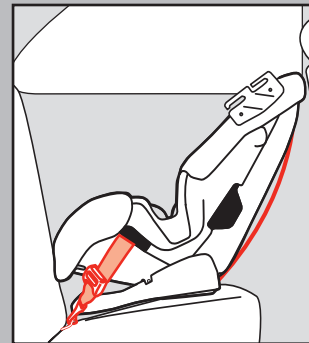

LATCH Belt

Rear-Facing Use: 5-35 lbs. (2.3-16 kg), 19-36" (48-91 cm)

⚠ WARNING:

This child restraint must always face the rear of the vehicle and be in the fully reclined position when the child weighs between 5-35 lbs. (2.3-16 kg) and is less than one year old.

 Never place a child rear-facing in a seating position with an active frontal airbag. This can result in serious injury or death.

Rear-Facing Installation

After deciding whether to use your Vehicle Belts or LATCH, be sure to read the warnings below as they pertain to both systems.

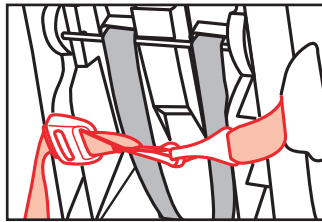

When LATCH is not available, fasten belt hooks together behind the child restraint as shown.

NOTE: Do not use the top anchorage strap (tether) in the rear-facing position. The top anchorage strap and hook should be placed under the child restraint.

⚠ WARNING:

A loose top anchorage (tether) strap can result in serious injury or death.

A loose LATCH system can result in serious injury or death.

Rear-Facing Installation with Vehicle Belt:

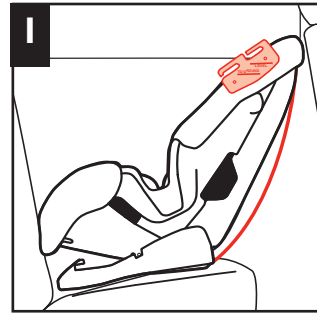

Place child restraint rear-facing in the back seat. With child restraint in the most reclined position, make sure level lines on shoulder belt positioning guide are level with ground. Adjust child restraint if needed.

NOTE: Tuck top anchorage strap and hook under the base.

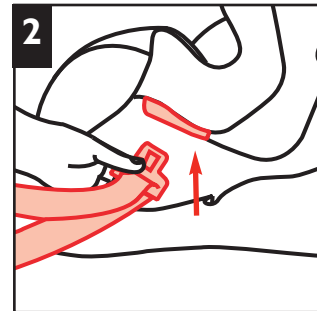

Thread the vehicle lap or lap/shoulder belt combination through the rear-facing belt slot.

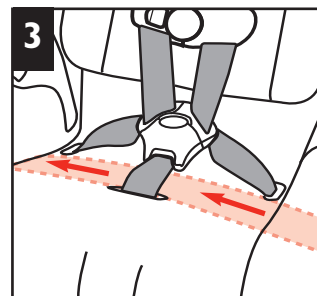

Thread **UNDER** seat pad between buckle strap and rear slots and out opposite side. Buckle vehicle belt.

Do not place vehicle belt over child's legs.

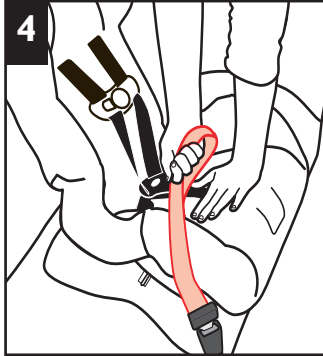

4 Push down firmly on the child restraint and pull up on belt to tighten. For a manual belt, refer to “Knowing Your Vehicle Belts” section. Pull up on shoulder strap to remove any slack.

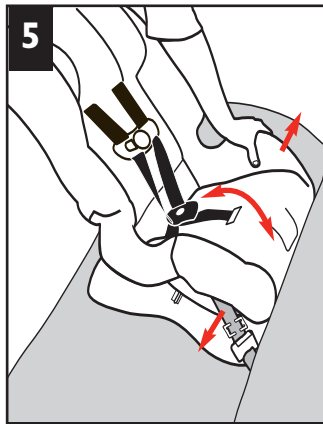

5 With weakest hand at belt path, tilt and push the child restraint forward and back, and from side to side. If the seat belts do not loosen, your child restraint should be secure. **NOTE:** Some “play” from front to back or about an inch from side to side is acceptable. If it moves more, review “Knowing Your Vehicle Belts” and “The Locking Clip” sections.

After checking for hot seat and buckles, secure child as described in “Securing Your Child in the Child Restraint” section.

⚠ WARNING

Using this child restraint in any vehicle seat where the lap belt cannot be tightened securely and properly or where it can be loosened by pulling on it, can result in serious injury or death.

Rear-Facing Installation with LATCH: Install LATCH Belt

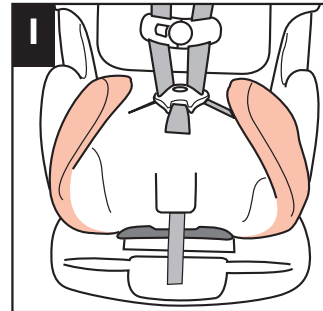

1 Do not use the LATCH system along with the adult lap or lap/shoulder belt.

To thread LATCH belts: Pull the seat pad off the front corners of shell.

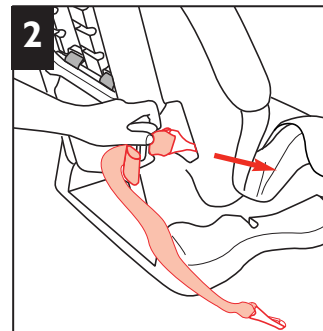

2 LATCH adjuster can be on either side, but belt should not be twisted.

Route entire LATCH belt through the upper slot in side of shell.

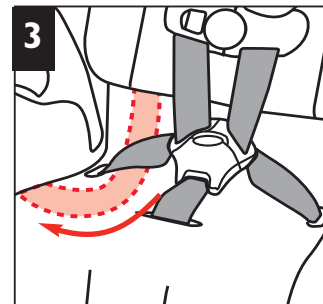

3 Reach under pad, pull one LATCH hook between rear harness slot and buckle strap.

Rear-Facing Use: 5-35 lbs. (2.3-16 kg), 19-36" (48-91 cm)

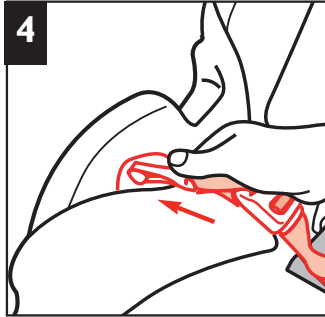

4 Push LATCH hook through the rear-facing belt path slot.

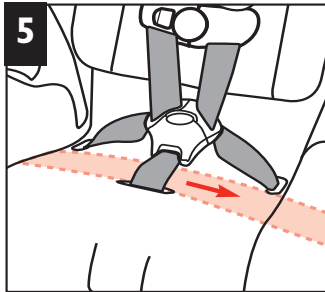

5 Pull other end of LATCH hook between buckle strap and rear harness slot.

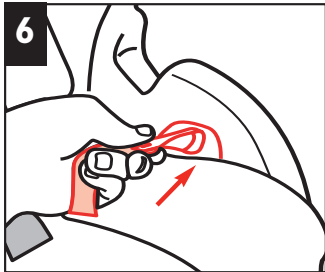

6 Push LATCH hook through the other rear-facing belt path slot.

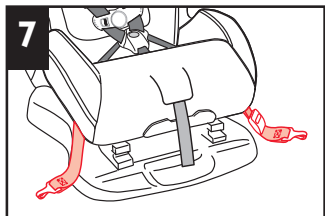

7 Put seat pad back over corners of shell.
Completed threading of the LATCH system rear-facing is shown.

Rear-Facing Installation with LATCH: Install in Vehicle

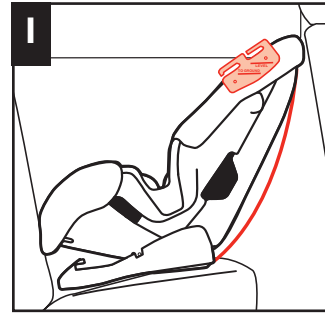

1 Place child restraint rear-facing in the back seat. With child restraint in the most reclined position, make sure level lines on shoulder belt positioning guide are level with ground. Adjust child restraint if needed.
NOTE: Tuck top anchorage strap and hook under the base.

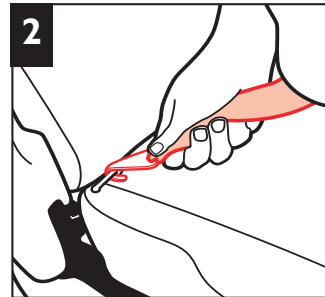

2 Fasten one LATCH belt hook to the anchor in the vehicle seat located in the vehicle seat bight. Repeat for other side of child restraint. See your vehicle owner's manual for more information.

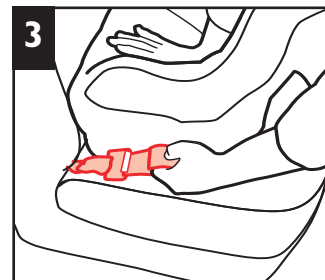

3 Push down firmly on the child restraint and pull up on the loop to tighten belt.

Rear-Facing Use: 5-35 lbs. (2.3-16 kg), 19-36" (48-91 cm)

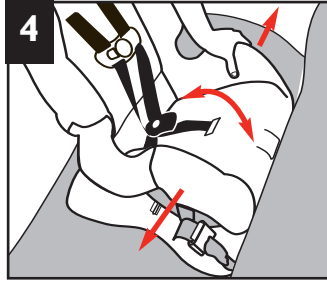

4 With weakest hand at belt path, tilt and push the child restraint forward and back, and from side to side. If the LATCH belts do not loosen, your child restraint should be secure.

NOTE: Some “play” from front to back or about an inch from side to side is acceptable.

If you cannot get the child restraint to remain tight, do not use the child restraint in this seating location with this LATCH system.

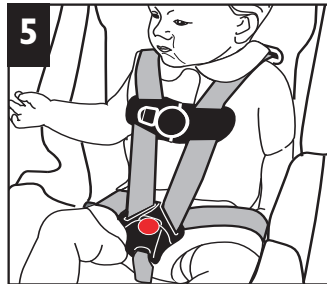

5 After checking for hot seat and buckles, place child in child restraint. See “Securing Your Child in the Child Restraint” section.

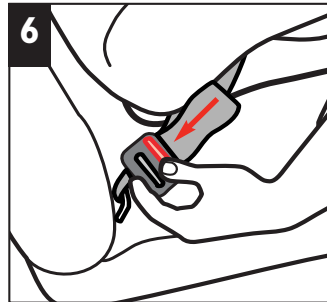

6 **To remove LATCH:** Push in on release button and pull LATCH adjuster away from child restraint to loosen. Unhook LATCH hooks.

⚠ WARNING

LATCH hooks MUST be securely fastened. Failure to do this can result in injury or death.

Forward-Facing Use

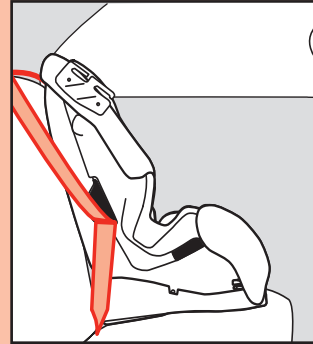

Lap/Shoulder Belt

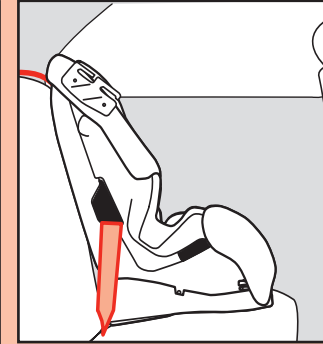

Lap Belt

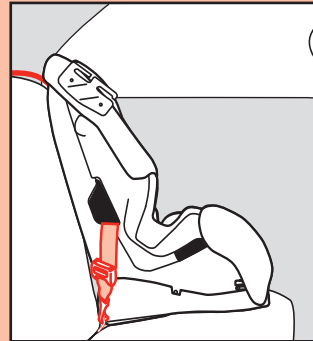

LATCH Belt

Refer to the “Choosing Restraint and Position” section to make sure your child is at the proper weight and height to face forward.

⚠ WARNING:

Using this child restraint in any vehicle seat where the lap or LATCH belts cannot be tightened securely and properly or where it can be loosened by pulling on it, can result in serious injury or death.

For vehicles with an airbag, but without a back seat, refer to your vehicle owner’s manual.

Forward-Facing Use: 22-50 lbs. (10.1-22.6 kg), 34-45” (85.1-114.3 cm), Over 1 year of age.

Forward-Facing Installation

After deciding whether to use your Vehicle Belts or LATCH, be sure to read the warning below as they pertain to both systems.

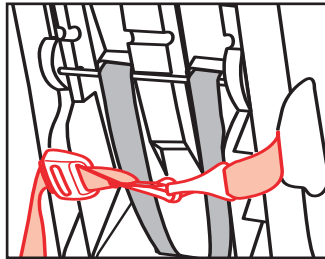

When LATCH is not being used, fasten belt hooks together behind the child restraint as shown.

⚠ WARNING:

A loose LATCH system can result in serious injury or death.

Forward-Facing Installation with Vehicle Belts:

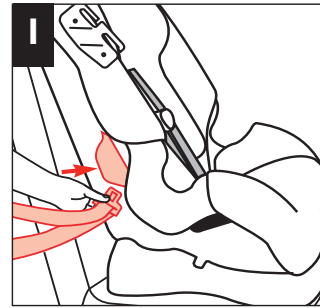

Place child restraint **flush** against the back of the vehicle seat **forward-facing** in the back seat.

The recline position is to be used only to install the child restraint flush against the back of the vehicle seat back, if needed.

Thread the vehicle lap belt or lap/shoulder belt combination through the belt path and out other side. Buckle.

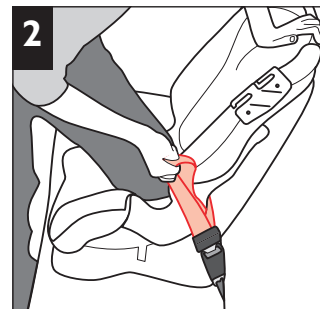

Place one knee in the child restraint and push down firmly while pulling up on belt to tighten. For a manual belt, refer to “Knowing Your Vehicle Belt” section.

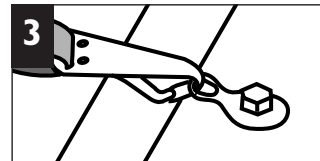

With knee still in child restraint, attach hook to anchor in vehicle. Push down firmly and tighten top anchorage strap.

To adjust top anchorage strap: See “Adjusting Top Anchorage Strap” section.

NOTE: If your vehicle does not have an anchor bracket, tuck the top anchorage strap’s hook under the child restraint.

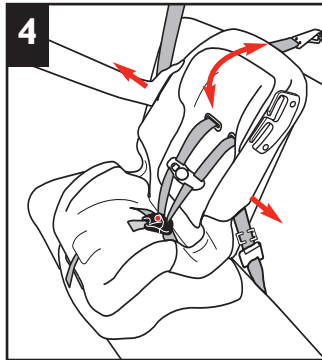

With weakest hand at belt path, tilt and push the child restraint forward and back, and from side to side. If the seat belts do not loosen, your child restraint should be secure.

NOTE: Some “play” from front to back or about an inch from side to side is acceptable. If it moves more, review “Knowing Your Vehicle Belts” and “The Locking Clip” sections.

⚠ WARNING

Using this child restraint in any vehicle seat where the lap belt cannot be tightened securely and properly or where it can be loosened by pulling on it, can result in serious injury or death.

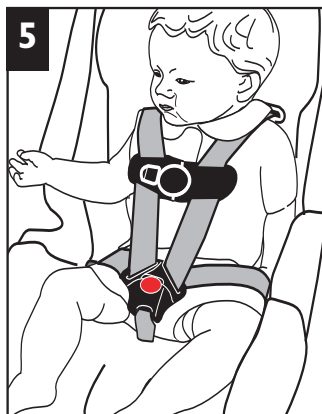

After checking for hot seat and buckles, place your child in the child restraint as described in the “Securing Your Child in the Child Restraint” section.

Forward-Facing Installation with LATCH Belt: Install LATCH Belts

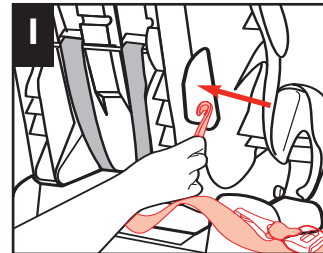

NOTE: Do not use LATCH system along with the adult lap or lap/shoulder belt.

Route LATCH belt through upper slot in side of shell.

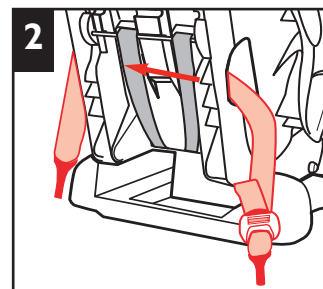

Pull one LATCH hook across the back and out the other side.

The LATCH adjuster can be on either side, but the belt should not be twisted.

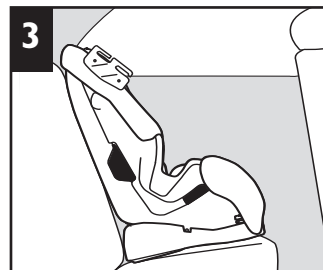

Place child restraint **flush** against the back of the vehicle seat **forward-facing** in the back seat.

The recline position is to be used only to install the child restraint flush against the back of the vehicle seat back, if needed.

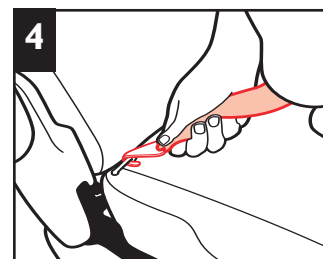

Fasten one LATCH belt hook to the anchor in the vehicle seat located in the vehicle seat bight. Repeat for other side of child restraint. See your vehicle owner’s manual for locations and more information.

Forward-Facing Use: 22-50 lbs. (10.1-22.6 kg), 34-45” (85.1-114.3 cm), Over 1 year of age.

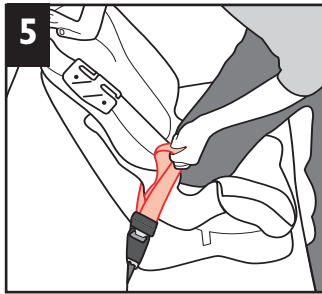

5 Place one knee in the child restraint and push down firmly while pulling up on the loop to tighten belt.

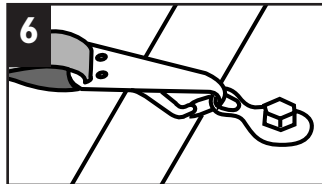

6 With knee still in child restraint, attach hook to anchor in vehicle. Push down firmly and tighten top anchorage strap.

To adjust top anchorage strap: See "Adjusting Top Anchorage Strap" section.

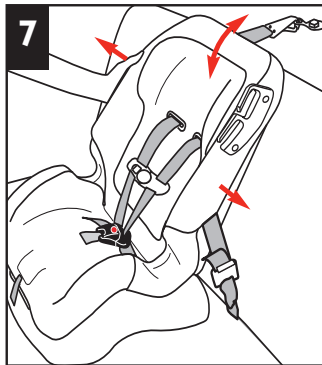

7 With weakest hand at belt path, tilt and push the child restraint forward and back, and from side to side. If the LATCH belts do not loosen, your child restraint should be secure.

NOTE: Some "play" from front to back or about an inch from side to side is acceptable.

If the child restraint does not remain tight, do not use the child restraint in this seating location with this LATCH system.

⚠ WARNING

LATCH hooks MUST be securely fastened. Failure to do this can result in serious injury or death.



8 After checking for hot seat and buckles, place your child in the child restraint as described in the "Securing Your Child in the Child Restraint" section.

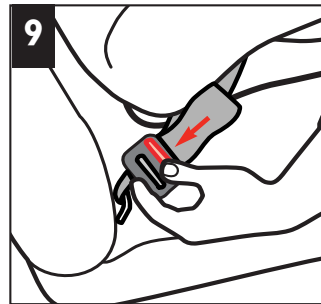

To remove LATCH: Push in on release button and pull LATCH adjuster away from child restraint to loosen. Unhook LATCH hooks.

Forward-Facing Use: 22-50 lbs. (10.1-22.6 kg), 34-45" (85.1-114.3 cm), Over 1 year of age.

Adjusting the Top Anchorage Strap

The top anchorage strap (tether) is used for the forward-facing position only.

Most vehicles made after 9/1/99 already have the anchor hardware for a top anchorage strap. Refer to your owner's manual or call your dealer.

Storage of Top Anchorage Strap:

Rear-Facing position: Place top anchorage strap over the back of the child restraint with the anchor hook secured under the base.

Belt-Positioning Booster position: Place top anchorage strap behind the seat with the anchor hook under the seat.

See pictures below and on next page to determine which tether model you have. Follow applicable steps.

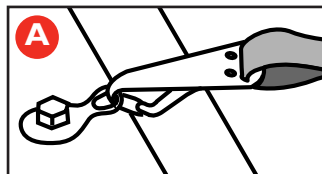

To Attach Top Anchorage Strap: Put knee in child restraint and push down; attach hook to anchor in vehicle.

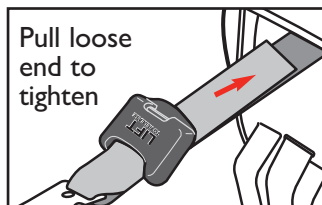

To Adjust Top Anchorage Strap: To tighten; pull on free end of top anchorage strap.

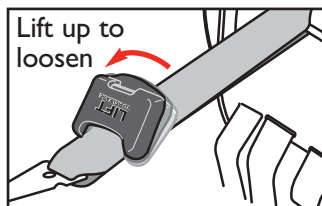

To loosen; lift up on top anchorage lock and push lock toward top anchorage hook.

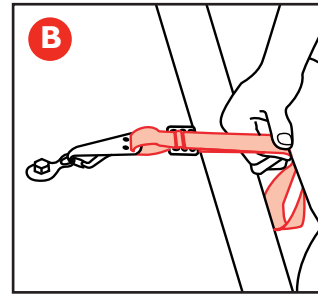

To Attach Top Anchorage Strap: Put knee in child restraint and push down; attach hook to anchor in vehicle to estimate how much adjustment you need, then unhook.

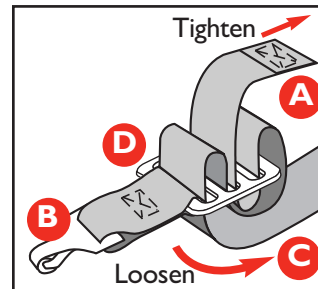

To Adjust Top Anchorage Strap: Loosen top anchorage strap into "loops" at adjuster slide as shown.

To tighten top anchorage strap: Pull on free end (A) of top anchorage strap while holding hook (B).

To loosen top anchorage strap: Pull on lower top anchorage strap (C) while holding adjusting slide (D) with your other hand.

Pull on free end of top anchorage strap until the "loops" are flush against the adjuster. Reattach hook to anchor to check fit, repeat steps if needed.

⚠ WARNING

You must follow the threading diagram exactly. Failure to follow these steps could cause the strap to loosen in a crash, which can result in serious injury or death.

Belt-Positioning Booster Use

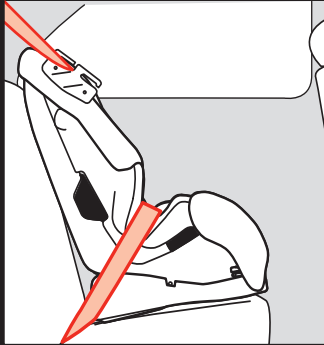

Lap/Shoulder Belt

Refer to the "Choosing Restraint and Position" section to make sure your child is at the proper weight and height to use the belt-positioning booster.

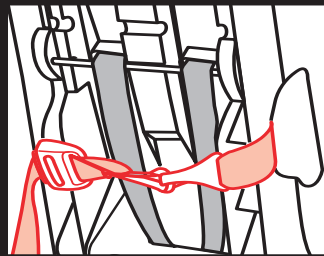

Do not use LATCH when using the belt-positioning booster. You MUST fasten the LATCH belt hooks together behind seat.

When your child is over 40 lbs. (18.1 kg) or 43" (110.1 cm) and over 1 year old, you must remove the harness system and use this seat as a belt-positioning booster.

⚠ WARNING

A loose LATCH system can result in serious injury or death.

Removal of Harness

Harness must be removed for use as a belt-positioning booster.

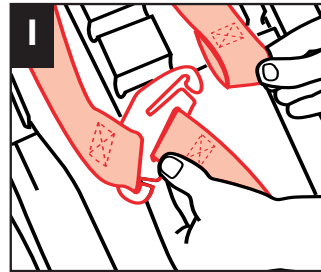

From the back of the seat, unfasten harness straps from splitter plate.

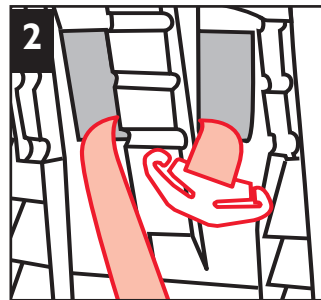

Store splitter plate by pushing it through one opening and out the other.

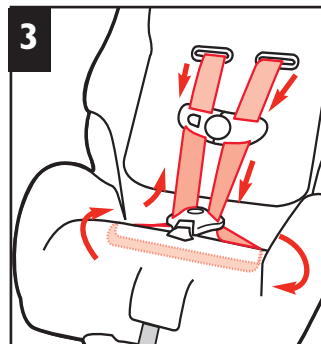

Pull harness through the slots and harness covers from the front.

Unthread harness from the chest clip.

Unthread harness from the buckle plates.

Pull harness out of shell.

Belt-Positioning Booster Use: 40-80 lbs. (18.1-36.3 kg), 43-52" (110.1-132.1 cm), Over 1 year of age.

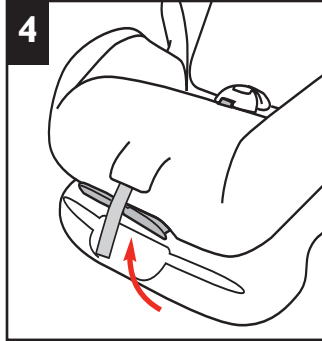

4 Fully recline the child restraint. Reach under the seat between base and shell. Locate the buckle's metal retainer.

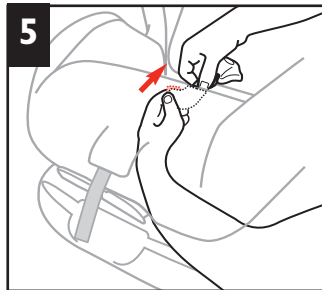

5 Rotate the metal retainer and then insert the retainer up through the shell and pad.

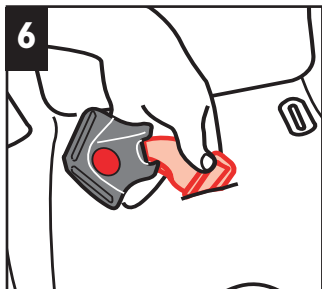

6 From the front, pull buckle free from shell and pad. Lock buckle plates into buckle for future use.

42

Belt-Positioning Booster Installation



1 Place booster seat against the back of the vehicle seat. Tuck the top anchorage hook under the child restraint. Have child sit in seat with his back and bottom fully in the seat.

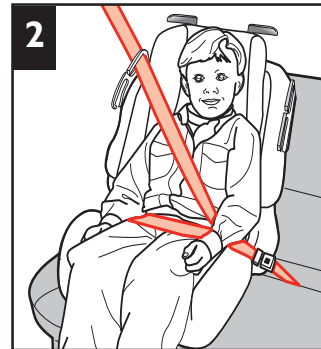

2 Place lap belt across child's thighs. Lock buckle.

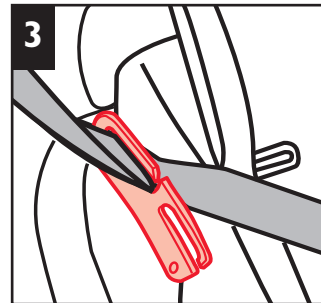

3 Secure the shoulder belt through one of the notches in the shoulder belt positioning guide. The belt should cross the base of the child's neck and lie across the chest (not the face or neck). Pull up on the shoulder belt to tighten.

Check periodically to ensure that your child has not moved out of position and loosened the shoulder belt.

43

continued on next page.

Belt-Positioning Booster Use: 40-80 lbs. (18.1-36.3 kg), 43-52" (110.1-132.1 cm), Over 1 year of age.

⚠ WARNING

For vehicles with an air bag, but without a back seat, refer to your vehicle owner's manual.

Do Not Use only the lap belt when using this seat as a belt-positioning booster without the internal harness.

The shoulder belt must always be adjusted snugly across the child's chest.

NEVER place the shoulder belt under the child's arms.

Use only the vehicle's lap and shoulder belt system when restraining the child in this booster seat.

Failure to follow these warnings can result in serious injury or death to your child.



Reinstall Harness

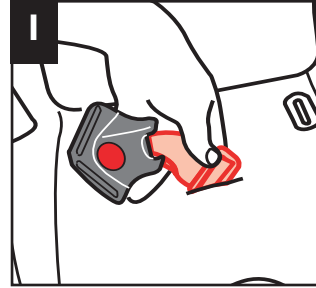

Fit the buckle strap down through the slot in the seat. Make sure buckle faces out. From the bottom of seat, pull buckle's metal clip completely through pad and shell.

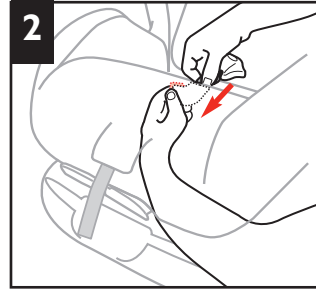

From the bottom of seat, pull buckle's metal clip completely through pad and shell.

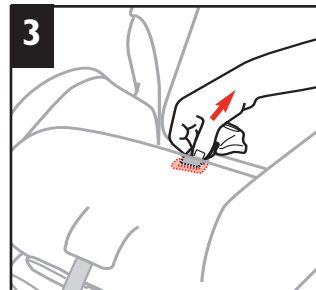

Pull up on buckle to make sure buckle's metal plate is completely through the pad and shell.

⚠ WARNING

Failure to place buckle's metal plate completely through pad and shell can result in serious injury or death to the child.

Belt-Positioning Booster Use: 40-80 lbs. (18.1-36.3 kg), 43-52" (110.1-132.1 cm), Over 1 year of age.

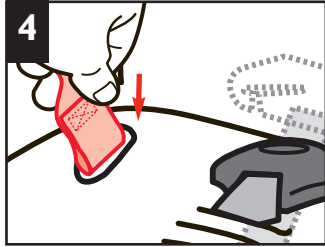

With the sewn end of the harness strap facing the buckle, thread the harness down through the slot on the left side of shell.

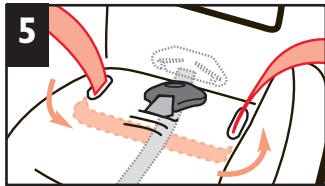

Pull harness across the bottom of the seat and up through the slot on the right side. **Make sure the harness is not twisted.**

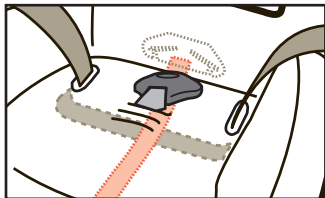

Take both ends of the harness strap and make them even in length.

NOTE: Make sure the harness adjustment strap is between the harness strap and shell as shown. **Harness adjustment strap should not be twisted.**

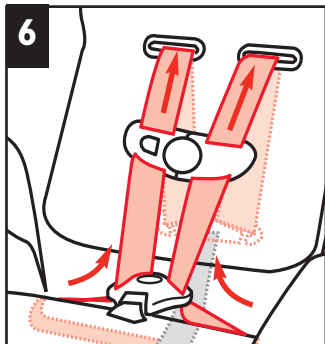

Thread the harness straps through each buckle tongue from the bottom up. Thread the chest clip.

Push harness ends through slot in headrest. Repeat for other harness strap.

DO NOT twist the harness strap.

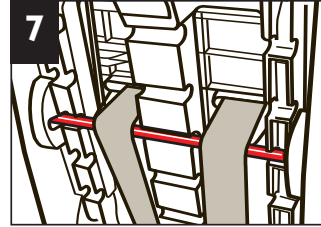

From the back, pull harness through the back. Make sure the **harness goes OVER the metal bar.**

⚠ WARNING

Failure to place harness over the metal bar can result in serious injury or death.

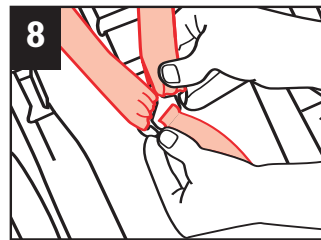

Fit loops on harness ends onto the splitter plate.

NOTE: Make sure harness is completely on splitter plate and it does not twist.

⚠ WARNING

Failure to reattach the harness system correctly can result in serious injury or death.

Removing Seat Pad for Cleaning

Remove harness as described in the “Belt-Positioning Booster” section.

⚠ WARNING

Do not use this child restraint without the seat pad. Failure to do this can result in serious injury.

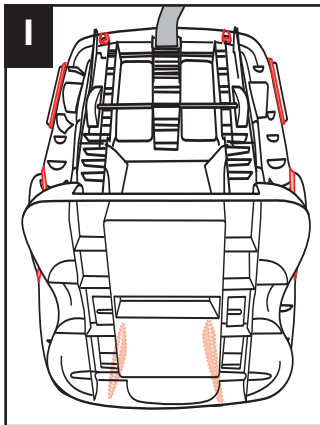

1 From back of shell, release the elastic straps.

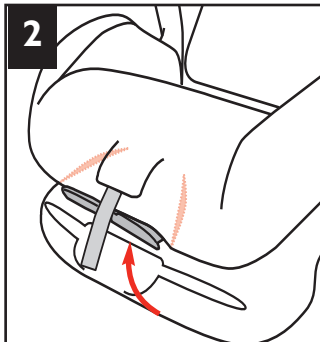

2 From the front, fully recline the child restraint and reach under the front of the shell, between shell and base, and release the front elastic straps.

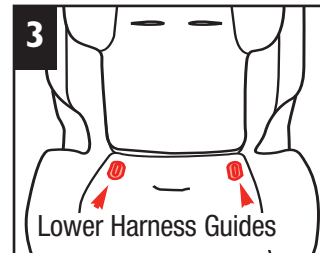

3 Remove harness guides in bottom of seat.

From the back of the seat, locate the lower harness guides that are between the bottom of the seat and base. Remove both lower harness guides in bottom of seat.

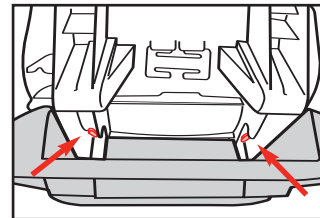

Push harness guide lip toward outside of shell with one hand while pulling harness guide from the front with the other.

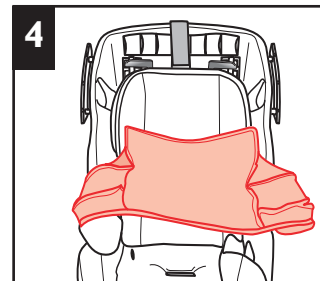

4 Adjust backrest to lowest position. Work pad off shoulder belt positioning guides and off of headrest.

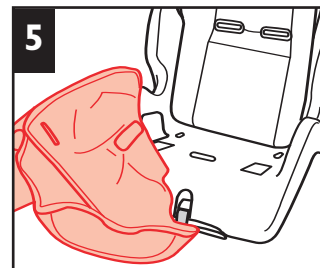

5 Pull pad out from under buckle cover and work it off the shell.

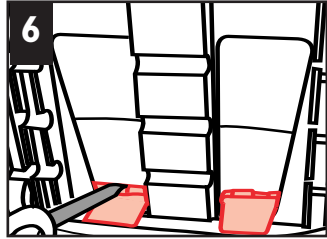

From the back, use a screwdriver to press in on lip of harness guide and pop guides through the front. Pull cover off headrest.

Hand wash with warm sudsy water, rinse clean and air dry. Do not use bleach or other harsh cleaners. Do not dry clean.

Spot clean harness straps. Do not machine wash.

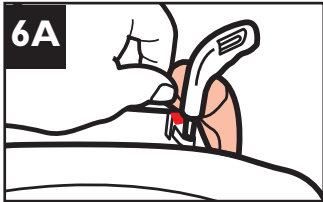

Depending on your model, to remove the headrest pad, pull pad off of the headrest tab located by the harness/headrest adjuster, then pull pad off of headrest.

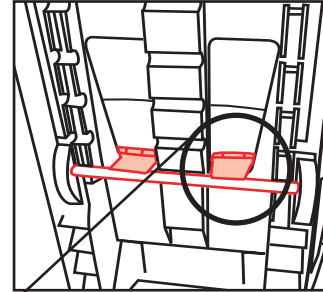

Replace seat pad by reversing order:

Put pad on headrest and replace harness guides.

Make sure harness guide's tab goes over metal bar.

Starting from bottom of child restraint, slip pad on shell; tuck in pad around harness adjuster and over upper belt guides. Make sure pad is under headrest and replace lower harness guides. Replace the headrest pad by starting from the top. Rethread harness (see belt-positioning booster section).

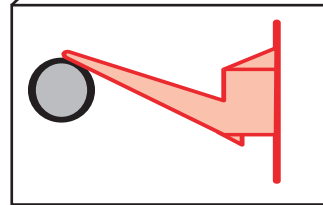

Troubleshooting

♦1. If your child restraint is not held securely by the belt:

Press down firmly on the child restraint and remove all the slack in the belt. Make sure the belt buckle is not up against the child restraint where the belt cannot be tightened. Review “Locking Clip” and “Adjusting the Top Anchorage Strap” sections. If you cannot secure the child restraint tightly, move it to another seating location.

♦2. If the child restraint buckle or harness adjustment lever sticks or you cannot get the straps tight enough around child:

DO NOT LUBRICATE. Check around buckle and harness release lever for dropped food, sticky spilled drinks, dirt, leaves, etc. Clean with warm water and/or remove object with tweezers. If you cannot get the harness to adjust and remain tight with the buckle securely locked, do not use the child restraint.

♦3. If your harness twists or ropes:

Straighten the harness each time you put your child in the seat to help prevent twisting. Lock the buckle and tighten harness and it will be ready for next use.

♦4. If your infant sits too upright in the rear-facing position:

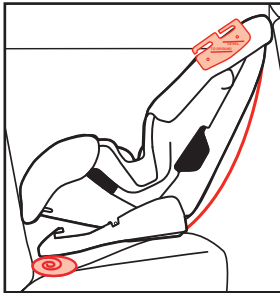

If your vehicle seat slopes so much that your infant is sitting upright, you may place a rolled towel under the front of the child restraint so that the level line on the shoulder belt positioning guide is level (horizontal). Check often to be sure padding is still in place and the vehicle belt is tight.

⚠ WARNING

Using padding that tilts the base of the child restraint farther back than the level-to-ground line can result in serious injury or death.

Warranty

Dorel Juvenile Group, Inc. (DJG) warrants this product to the original retail purchaser as follows:

This product is warranted against defective materials or workmanship for seven years from the date of original purchase. **An original receipt is required to validate your warranty.** DJG will, at its option, provide replacement parts or replace this product. DJG reserves the right to substitute if the part or model has been discontinued.

To make a claim under this warranty you may contact us at www.djgusa.com, fax us at 1-800-207-8182 24 hours a day, write to DJG, Consumer Relations Department, P. O. Box 2609, Columbus, IN 47202-2609, or call 1-800-544-1108 from 7:00 a.m. to 6:00 p.m. EST Monday through Thursday and from 7:00 a.m. to 4:30 p.m. on Friday. **Proof of purchase is required and shipping charges are the responsibility of the consumer.**

Warranty Limitations:

This warranty does not include damages which arise from misuse or abuse of this product.

Limitation of Damages:

The warranty and remedies as set forth are exclusive and in lieu of all others, oral or written, expressed or implied. In no event will DJG or the dealer selling this product be liable to you for any damages, including incidental or consequential damages, arising out of the use or inability to use this product.

Limitation of warranties and other warranty terms and state law rights:

Any implied warranties, including implied warranties of the merchantability and fitness for a particular purpose, shall be limited to the duration and terms of the express written warranty. Some states do not allow limitations as to how long an implied warranty lasts or the exclusion or limitation of incidental or consequential damages, so the above limitations may not apply to you. This warranty gives you specific legal rights, and you may have other rights, which vary from state to state. Neither DJG nor the dealer selling this product authorized any person to create for it any other warranty, obligation, or liability in connection with this product.

PLEASE COMPLETE AND MAIL THE PRE-ADDRESSED OWNER REGISTRATION CARD WITHIN (30) DAYS OF PURCHASE TO EXPEDITE WARRANTY CLAIMS AND TO VERIFY THE ORIGINAL DATE OF PURCHASE.

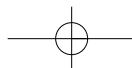
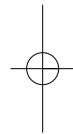
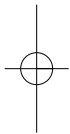
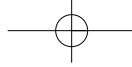

Replacement Parts Order Form

Complete the form below. Your model number with color code and manufacturer date code **MUST** be included on the form to ensure proper replacement parts. Your model number with color code and the date code can be found on a sticker on the side of child restraint. Payment in U.S. dollars must accompany your order. Choose parts needed from the list on next page.

Return the form with payment to:

Dorel Juvenile Group, Inc.
Consumer Relations Department
P.O. Box 2609
Columbus, IN 47202-2609

Fax orders to: 1-800-207-8182

Please make money orders payable to Dorel Juvenile Group, Inc. Fill in the area below to charge to Visa or Mastercard. We do not accept personal checks or Discover Card. All outside of U.S. and Canada **MUST** use credit card.

Ship To (Please Print): _____

Name: _____

Address: _____

City: _____

State/Province: _____ Zip _____

Telephone: _____

Email Address: _____

We **MUST have this information to process your order:**

Model Number (5 digits & 3 letters): _____

Manufacture Date (mm/dd/yyyy): _____